

Best Practices Guide for Installing Solid Wood Cladding

Second Edition



Project Managers

Myriam Drouin, Innovation Support Specialist, Strategic Foresight, FPInnovations
Nicolas Pearson, Industrial Advisor, FPInnovations.

Acknowledgements

Many collaborators worked together to produce this guide:

Writing:

- Alain Gagnon / Martin Scallon, Groupe Crête
- Benoit Schmitt, Maibec
- Éric Venne, Groupe Concept PV
- Guy Simard, APCHQ – Quebec City Region
- Jean-Luc Ouellette / Alain Lavoie, Juste-du-Pin
- Jean-René Jacob / Pierre Beaudoin, Maxi-Forêt
- Lara Sioui, Revêtement Premium
- Michel Brunet, Goodfellow
- Simon Martin, Fraser Wood Siding

Secondary contributors:

- Donia Melanson, MEL Innovation
- Julie Côté, Plafond, Lambris & Cie Inc
- Caroline Frenette, Francois Charette, Kevin Gazeau et Richard Poirier, Cecobois

Technical drawing production:

- Louise Armstrong
- Appalaches Solutions Bois Inc

Funding:

This guide was funded by the Signature Bois Laurentides excellence cluster via the ministère de l'Économie, de la Science et de l'Innovation, le ministère des Forêts, de la Faune et des Parcs du Québec, along with Natural Resources Canada.

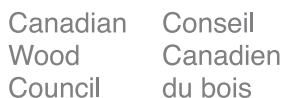

Disclaimer

Although this guide was designed with as much precision as possible, in accordance with current practices for wood cladding, Cecobois, Wood *WORKS!* and the Canadian Wood Council are not liable for any errors or omissions that may arise from the use of this guide. All users of this guide fully assume all risks and responsibilities associated with it.

This guide presents the best manufacturer installation practices. It supplements the codes and standards and manufacturer installation guides, but is not a replacement or substitute for these. As such, it is the installer's duty and responsibility to take all available documentation into account prior to completing work to ensure the validity of manufacturer warranties.

Finally, to ensure simplification, the technical drawings in this guide do not show all construction details to meet requirements of codes and standards.

Note

This version of the Guide of Best Practices for Installing Solid Wood Cladding is an abridged version. The complete version of the guide may be obtained from FPInnovations (www.fpinnovations.ca). Cecobois collaborated to format and publish this guide.

Table of Contents

Project Managers	ii
Acknowledgements	ii
Disclaimer	iii
Note	iii
Table of Contents	iv
1. Preparation	1
1.1 Receiving and storing materials at work site	1
1.2 Materials required	2
1.3 Wall straightening and corrections	2
1.4 Flashing and weather barriers	2
1.5 Furring strips	3
1.6 Opening contours	5
1.7 Junctions with other cladding	7
2. Installation	9
2.1 Spaces	9
2.2 Openings for ventilation	9
2.3 Organization of lengths and butt joints	13
2.4 Cutting	14
2.5 Touch-ups	15
2.6 Cladding fasteners	16
2.7 Installing cladding	19
2.8 Sealant	21
3. Maintenance	22
3.1 Cleaning	22
3.2 Minor maintenance	23
4. References	23

1 Preparation

1.1 Receiving and storing materials at work site

Best practices in installing wood cladding begin with proper material receipt and storage.

Upon receipt of the materials, an inspection is required. Customers must ensure that the product is the correct model, colour and quantity they ordered. If the cladding is delivered damaged, it must not be installed. You should take note of any alteration to the packaging. If you notice a problem, contact the supplier as soon as possible. Cladding manufacturers or suppliers are not generally required to replace damaged cladding once it has been installed or altered in any way.

It is recommended that you install the cladding as quickly as possible after you receive it in order to prevent risks of variation in the product's moisture content, which may lead to warping in the boards or variation in size. Optimal storage conditions are the best bet for maintaining the quality and stability of your cladding, from the time you receive it to the time it is installed.

The cladding must be stored in a place that will maintain its original condition—it should be dry and well-ventilated, not heated, on a flat and dry surface, and at a distance of 150 mm (6 in) off the ground to allow for good airflow below the package (Figure 1). An ideal example is a carport with open sides or a gazebo. When such a location is available, the packaging may remain open during the work. Otherwise, the covering provided by the manufacturer must be kept on the package at all time, as long as it has maintained its waterproofing, without which it must be replaced by a new, equivalent covering. You must also keep the plastic film between the boards to prevent them from sticking together. Whether in a special storage area or not, any cladding remaining at the end of the day must be protected or at least covered by the manufacturer's covering.

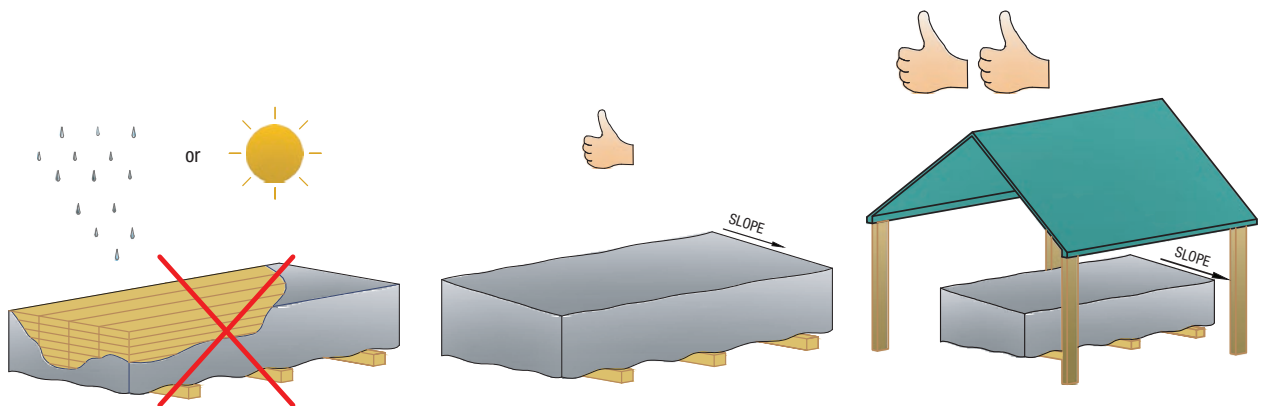

FIGURE 1 • Storage of cladding on site

1.2 Materials required

Prior to beginning work on site, the person responsible must ensure that they have all materials necessary for the installation. The list below contains the main necessary components:

Cladding and mouldings

- Correct colour
- Correct shape
- Sufficient quantity

Finishing product for touch-ups (provided by cladding manufacturer)

- Correct colour
- Sufficient quantity

Installation accessories

- Metal starting strips
- Metal finishing strips for upper walls or screens
- Screens
- Manufacturer-recommended staples and/or nails

Tools

- Pneumatic nailer or stapler for 1) cladding, 2) finishing strips (if needed)
- Compressors with adequate capacity to supply air for pneumatic tools
- Laser level
- Manual level
- Mitre saw
- Scroll saw
- Finish blade
- Sheet metal brake (to make flashing)
- Hammer
- Plastic cap for hammer head
- Sheet metal snips
- Fine or applicator brush

1.3 Wall straightening and corrections

For proper installation, the wall to be covered in cladding must be generally flat. Significant differences in the evenness between two or several adjacent furring strips will warp the wall cladding and the resulting ripples may be visible depending on lighting. Significant ripples could also seriously constrain the fastening systems used to hold the cladding in place. Corrections are recommended when the amplitude of the ripples is greater than 5 mm (0.2 in) for one furring strip compared to two adjacent furring strips (**Figure 2**).

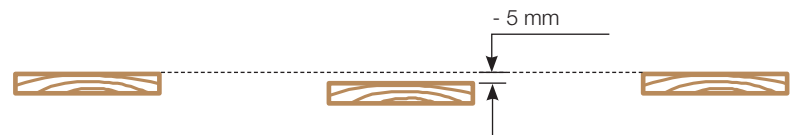

FIGURE 2 • Ripple amplitude of one furring strip compared to two adjacent furring strips

1.4 Flashing and weather barriers

Installers must make sure that there are flashing and weather barriers, that they are installed in compliance with local codes, and that the installation meets manufacturer requirements. Remember that the purpose of weather barriers and flashing is to dissipate water to the exterior. An error may cause a leak and premature wall damage.

Flashings ensure building water tightness between two different construction materials. Installers must make sure that the necessary flashing is constructed correctly (**Figure 3**), in compliance with codes and standards in effect, and that they are present in the following proper locations:

- Openings (doors and windows)
- Wall/ceiling junction
- Chimney
- Transition between another type of cladding or surface

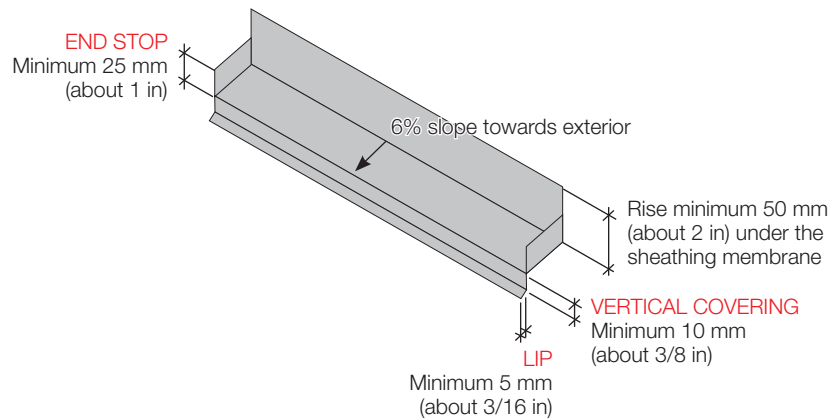

FIGURE 3 • Flashing specifications for openings (Source: APCHQ)

1.5 Furring strips

For proper maintenance of solid wood cladding, it is important to install the necessary furring strips. The dimensions of the furring, their position and spacing depend primarily on the shape of the cladding used (width, thickness) and the orientation of the cladding boards (horizontal, vertical, diagonal).

For renovations, it is necessary to replace any or all damaged furring strips as needed.

1.5.1 Type of furring strips

Furring strips are commonly made of wood: SPF (spruce-pine-fir) boards or marine-grade plywood in the same size. The cladding is then nailed or stapled to the furring. In some commercial or institutional buildings, metal furring is sometimes used—for example, stainless steel, Z section or Omega. This requires the addition of a wood nail-holding base as described below.

1.5.2 Dimensions and position of furring

In residential and commercial construction, a common type of furring available is 25 mm x 76 mm (1 in x 3 in). Some more severe conditions require thicker or wider backing—for example, with larger width cladding, dark colours and/or surfaces with high sun exposure.

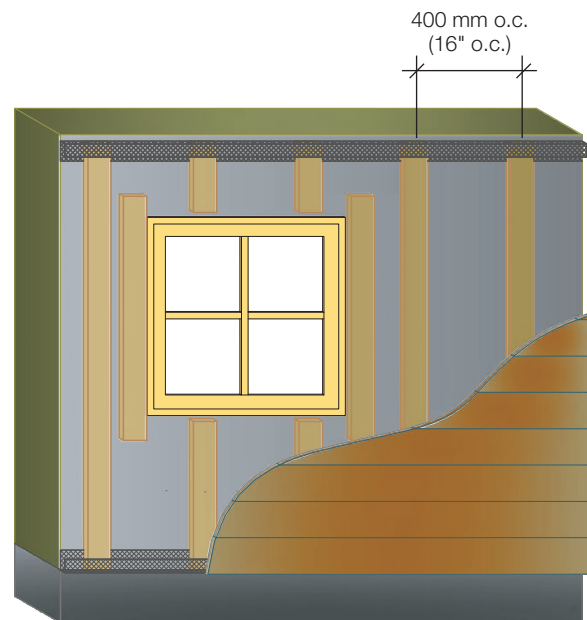

FIGURE 4 • Position of furring strips for horizontal cladding

All furring must be firmly attached to the building structure. To ensure the cavity drains and ventilates adequately, only vertical furring is accepted directly on weather barriers at 400 mm centre to centre (16 in o.c.).

The best practice is to install furring following the primary methods of installation as shown in the following images.

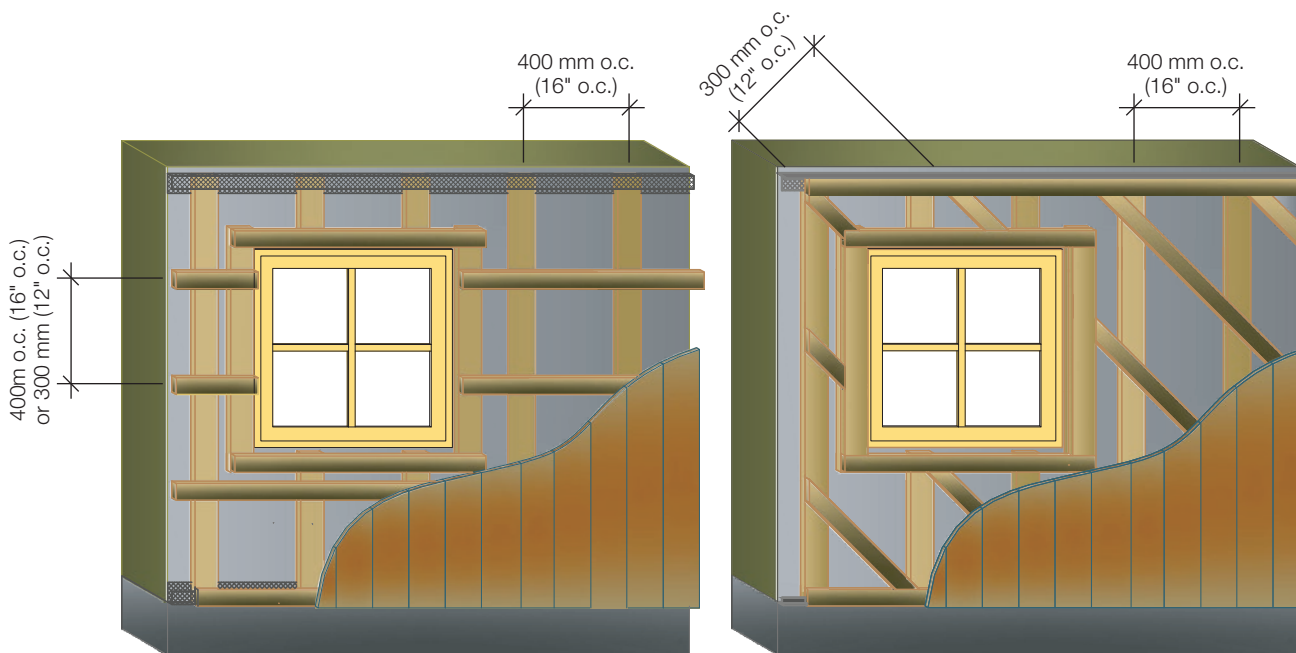

FIGURE 5 • Position of furring strips for horizontal cladding

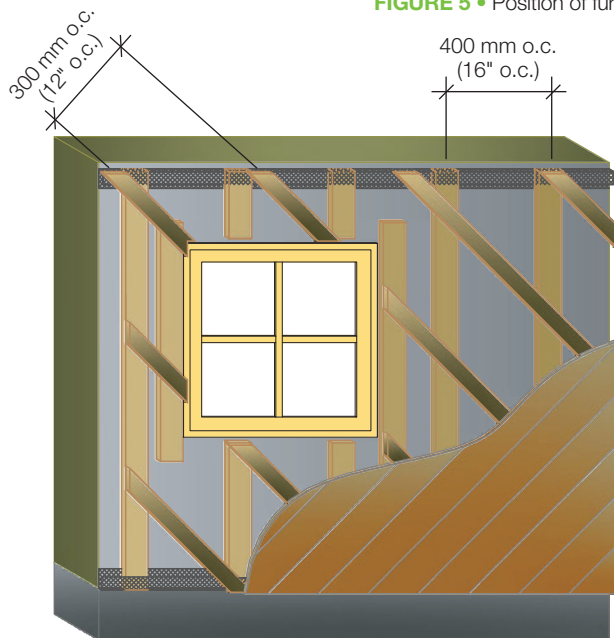

FIGURE 6 • Position of furring strips for diagonal cladding

1.5.3 Cladding surface over 6 metres tall

The dimensions and spacing for furring shown above apply for walls of a maximum height of 6 metres. If the cladding surface exceeds this height, the following is necessary for proper ventilation:

- Either increase the width of the furring and opening at the top and bottom of the walls;
- Or compartmentalize, by breaking up and expelling the air space by integrating new openings and air outlets in each section of the wall (maximum 6 metres). Refer to Figure 16 to view the impact on the furring strips of breaking up the air space on the second board.

1.5.4 Attaching furring strips

The furring strips must be fixed to the wall frame. It is recommended that the fasteners penetrate the solid frame by at least 32 mm (1¼ in). Depending on the wall's construction and the energy efficiency standard in effect for the building's envelope, it is now common to add insulation on the wall's exterior. The length of fasteners must be adjusted accordingly so that they penetrate at least 32 mm (1¼ in) into the frame.

Resin-coated spiral nails are the recommended type of fastener. Two (2) nails are installed at the ends of the furring, and then one (1) nail at every 300 mm (12 in) vertically. For installation methods requiring a double lathing, the second row of furring strips requires two (2) nails at the ends of the furring, and then also two (2) nails at each furring strip in the first row, every 400 mm (16 in).

NOTE:

The installation of double furring strips (laths) as illustrated above creates an air space of 38 mm behind the exterior cladding. However, for any air space greater than 25 mm under the cladding, most construction codes require that sheet steel fire blocking 0.38 mm thick (article 9.10.16.3.2a) be installed at the level of each board (article 3.1.11.2.1a) horizontally, to leave a maximum of 20 mm of horizontal distance and 3 m of vertical distance between the fire blocks (article 3.1.11.2.1c). This detail will be similar to Figure 16 of the guide, but with double furring strips (double laths).

1.5.5 Installation specifications

When the wall exterior is aligned with the foundation, it is recommended that the furring strips cover the foundation by at least 25 mm (1 in). If the wall is set back from the foundation, or when there is masonry at the base of walls, refer to **Figure 10, 11** and **13** for design recommendations.

1.5.6 Protective barriers

Furring strips create a ventilated cavity between the wall and the cladding. The presence of this cavity, or air space, is essential because it enables water, humidity and heat to escape where it may otherwise accumulate. This cavity therefore needs to be open, at the top and bottom of walls as well as openings, in order to ensure good air circulation in the cavity. These openings must remain free at all times of sealant or any other material obstructing air circulation.

Functional statement F42 of the National Building Code (NBC) stipulates that the building must resist the entry of vermin and insects (NRC, 2012). It is therefore recommended to install ventilation components at the base and top of walls to prevent vermin and insects from settling behind the cladding (moulding, anti-rodent grille or metal screen) (**Figure 7**). Some manufacturers make metal moulding that provides this protection.

NOTES:

- Avoid installing horizontal furring strips at the base and top of the wall, because they will prevent good ventilation and free drainage.
- To meet the NBC's requirements, the air space should not be adjacent to the concealed space under the roof¹.

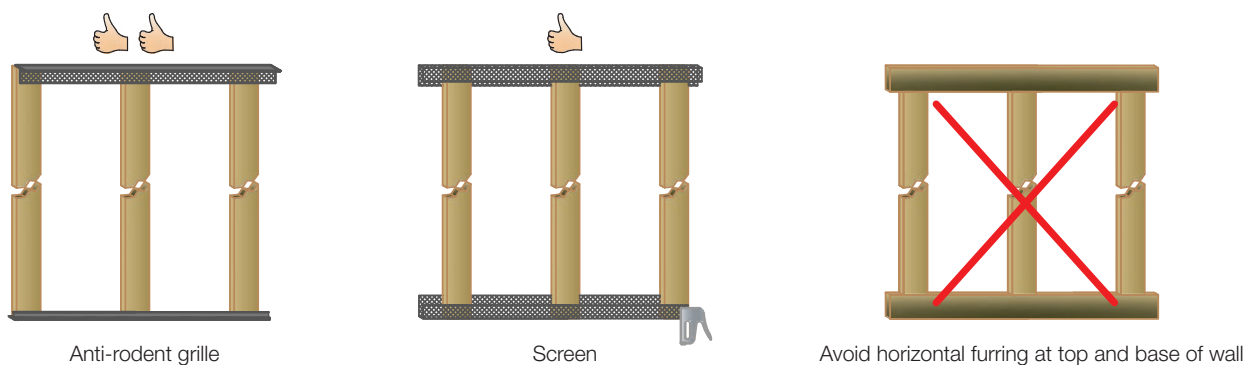

FIGURE 7 • Protective barriers at the base and top of walls

¹ <https://www.garantiegr.com/fr/echo-gcr/protection-minimale-contre-les-infiltrations-de-precipitations/>

For optimal ventilation, the back cavity should be of minimal dimensions. The open space of the back cavity should generally be at least 10 mm (3/8 in). The size and orientation of the furring as well as the airflow percentage from the installed ventilation component determine this size.

1.6 Opening contours

Prior to installing furring strips and/or finishing moulding around openings (doors, windows, conduits, etc.), make sure that the weather barrier membrane is watertight to prevent water from entering the wall structure. You must also install metal flashing above all doors and windows to allow water drainage. Weather barriers should overlap the flashing by 50 mm (2 in). Furring strips should leave a space of about 25 mm (1 in) above the horizontal part of the flashing so they are not visible once the cladding is installed.

Install furring strips making sure to not press them directly on the frame of the opening in order to allow for water drainage and facilitate door or window installation or replacement. The following spacing is recommended (**Figure 8**).

Above the opening:

- 25 mm (1 in) between the flashing and furring
- 10 mm (3/8 in) between the flashing and cladding

On the sides:

- 12 mm (1/2 in) between the frame and furring

Under the opening:

- 12 mm (1/2 in) between the frame and furring
- 10 mm (3/8 in) between the cladding and flashing

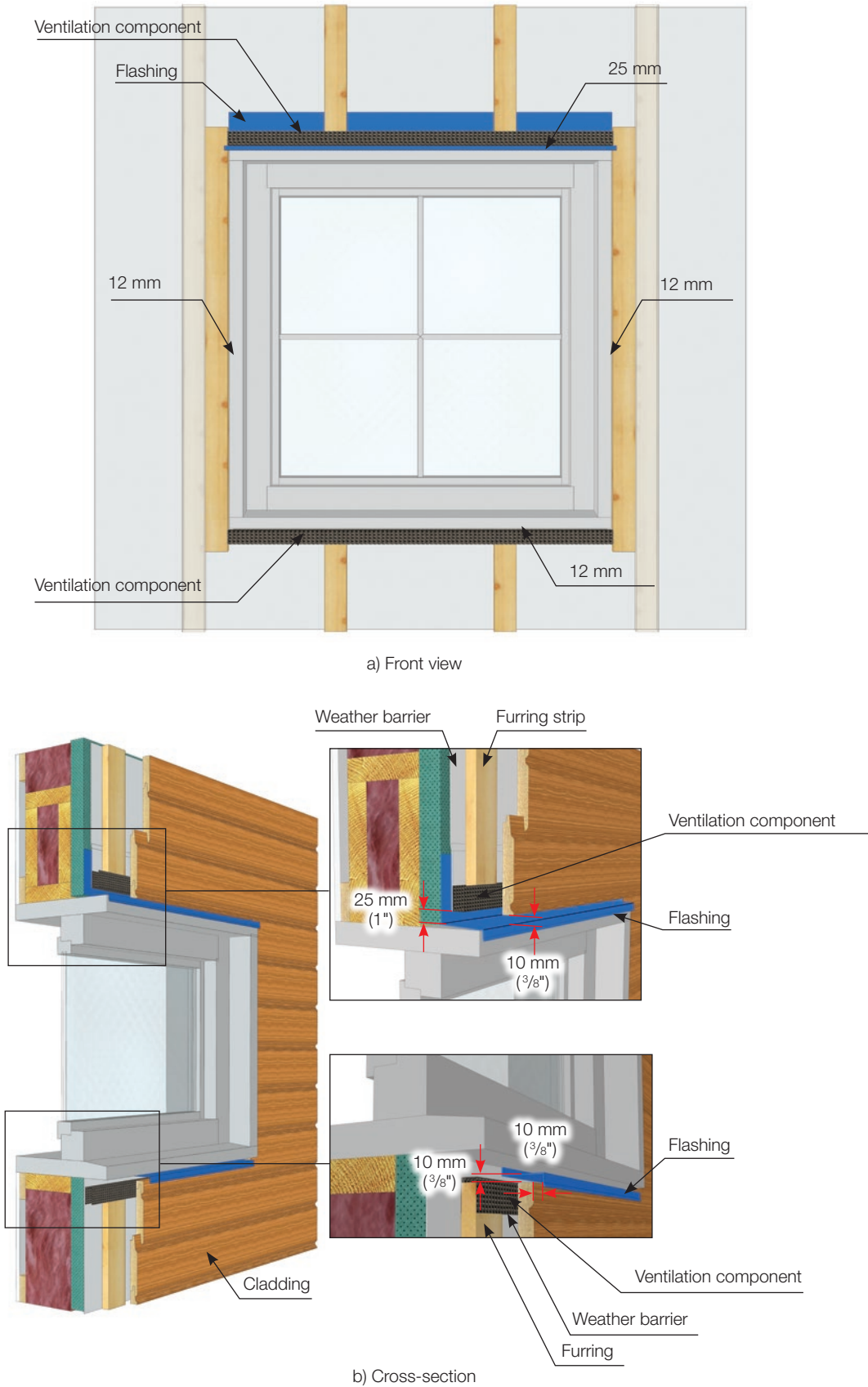

FIGURE 8 • Preparation of walls around openings (without finishing moulding)

If finishing mouldings are installed onto frame openings, flashing must be added above the upper moulding. The same orientation for furring applies (**Figure 9**).

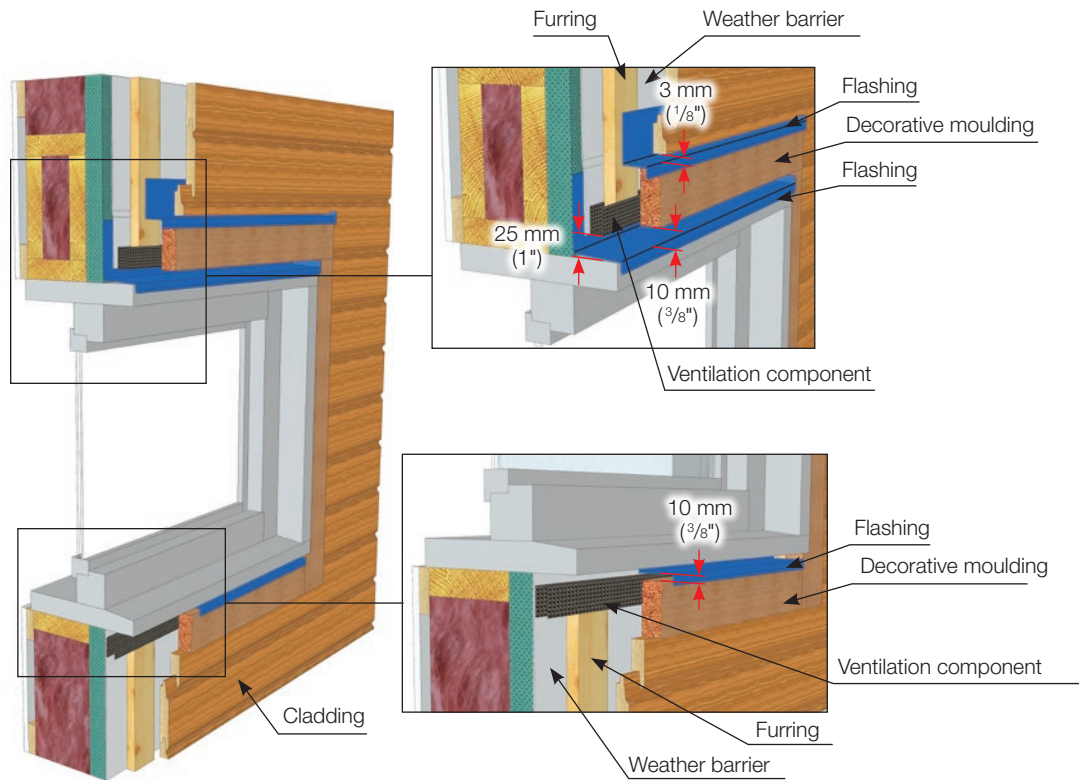

FIGURE 9 • Preparation of walls around openings (with finishing moulding)

1.7 Junctions with other cladding

It is common for a dwelling's walls to be covered in more than one type of cladding. For example, a wall with solid wood cladding might have a base in masonry, panelized stone or faux stone. It is important to install the flashing necessary for water drainage and to have an opening above the flashing for ventilation and drainage. Where the two types of cladding meet, there should be a minimum of 10 mm (3/8 in) clearance between the two, depending on how far the element protrudes. For large protruding elements, the space can be increased to 25 mm (1 in).

1.7.1 Masonry sleeper wall

As a general rule, a stone apron is installed above a masonry sleeper wall. This requires the installation of flashing for water drainage. The upper section of the flashing must be under the weather barrier and under the furring. The furring must leave a space of 38 mm (1 1/2 in) above the horizontal part of the flashing (**Figure 10**). In this specific case, the flashing rests on the apron, and a sealant is applied to prevent water ingress under the flashing. Depending on the thickness of the masonry wall, maintain clearance of 10 mm (3/8 in) to 25 mm (1 in) between the cladding and the flashing. To ensure good ventilation and drainage, the wood should not touch the flat surface of the flashing. This means that no sealant should be applied to connect the flashing and wood cladding.

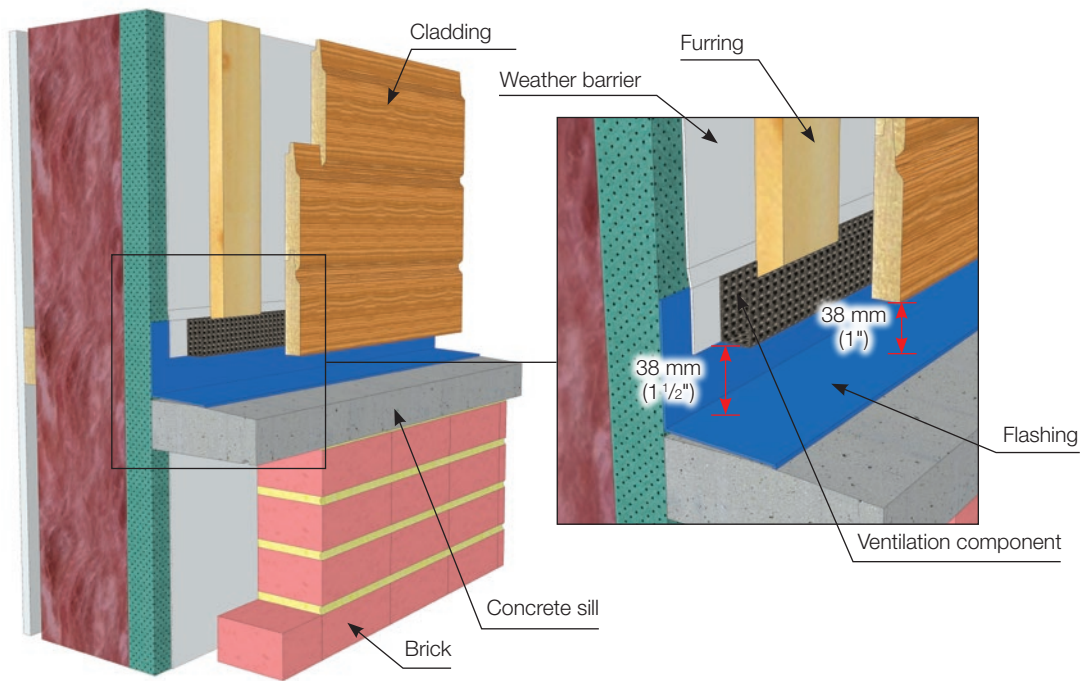

FIGURE 10 • Preparing walls at junction of masonry sleeper wall

1.7.2 Other cladding with ventilated air space

For transitions with another type of cladding with an adequately ventilated air space (an open free space at least 10 continuous mm (3/8 in)), only one transition

flashing is necessary (**Figure 11**). Since this section of cladding maintains continuity in ventilation, it is included in the 6 metre maximum height for the cladding surface (section 2.2.1).

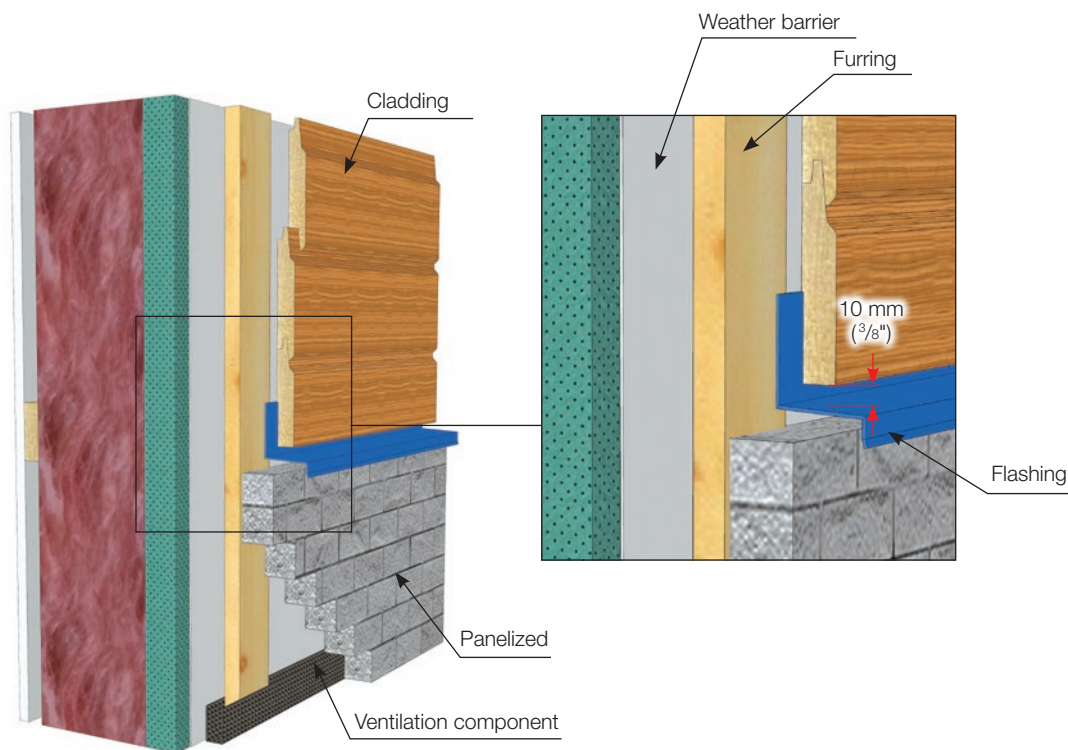

FIGURE 11 • Preparing walls at junction of a panelized stone wall (or faux stone)

2 Installation

2.1 Spaces

Wood cladding must have the following minimum distances from surfaces below in order to prevent deterioration from excessive humidity or nearby water:

- 200 mm (8 in) above the ground
- 50 mm (2 in) above inclined roofing
- 200 mm (8 in) above flat roofing
- 50 mm (2 in) above a patio
- 25 mm (1 in) above a lintel

In situations where it is difficult to leave this amount of clearance, the responsibility lies with the designer or construction contractor to adapt the design and installation to attain the same objective.

2.2 Openings for ventilation

2.2.1 Openings

As described previously, it is recommended to install openings at the base and top of walls that link directly with the back cavity. These openings are crucial for letting out water, moisture and heat that can accumulate behind the cladding. On a foundation wall, which is normally aligned with this wall, this opening is not necessary because the cavity is directly exposed (**Figure 13a**). However, if the foundation sticks out beyond the wall towards the exterior, flashing must be installed and a 10 mm (3/8 in) opening must be placed between the cladding and flashing (**Figure 13b**).

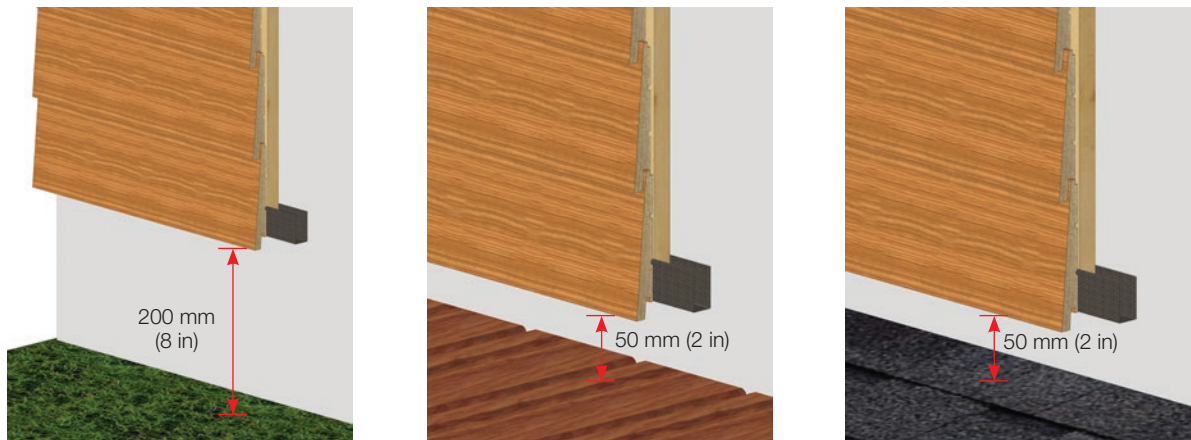
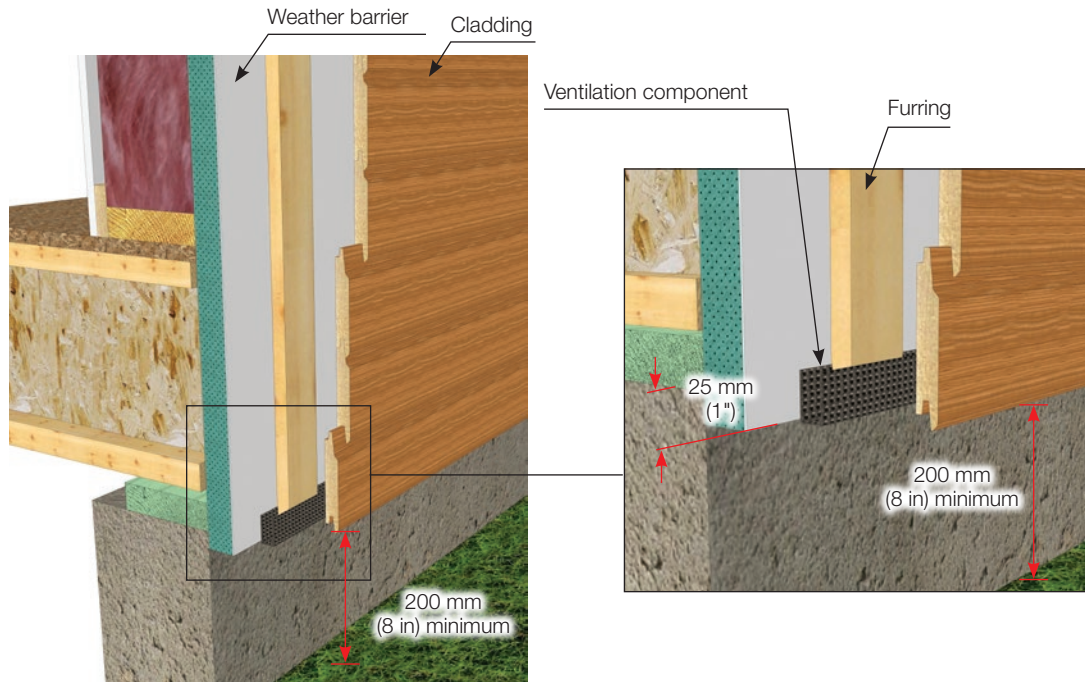
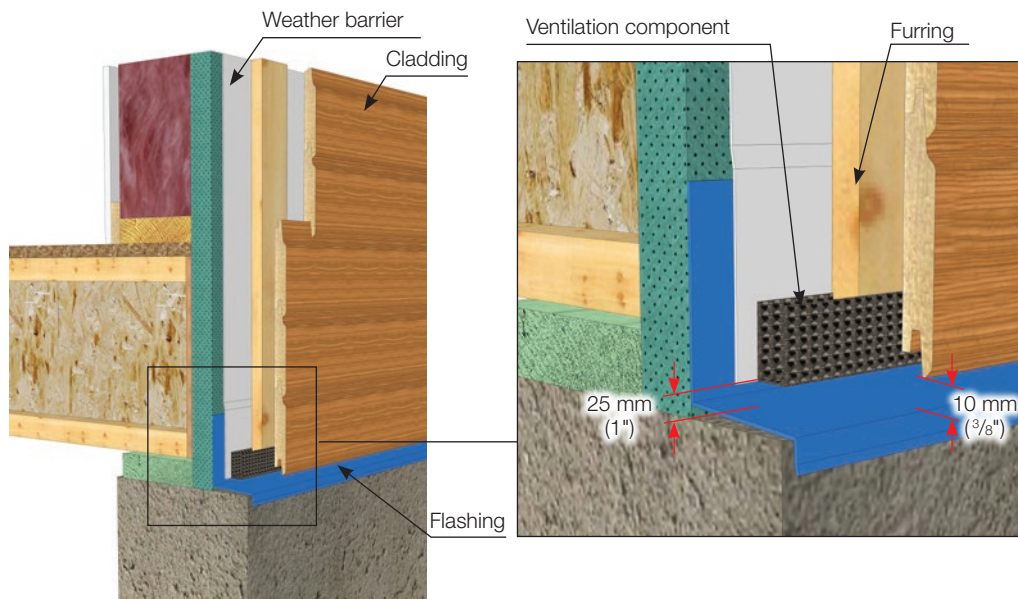

FIGURE 12 • Minimum clearance of cladding above a surface



a) Foundation aligned with the wall



b) Foundation sticking out beyond wall

FIGURE 13 • Opening at the base of the walls

At the top of the wall, a minimum of 10 mm (3/8 in) of open space (free of any obstruction) is also necessary between the cladding and the roof, but it will be different depending on the type of roof. It is important to note that the NBC requires a break in the

contiguity between the back cavity and the under-roof air space (art 9.27.2.2.3) (CNRC, 2015). There are several possible solutions, including the two examples presented in **Figures 14** and **15**.

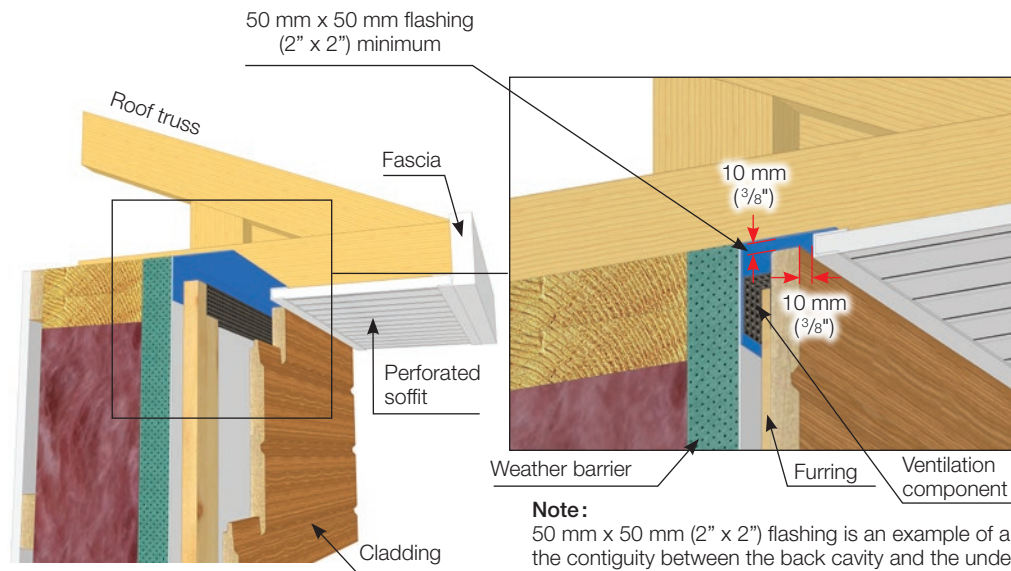

Note:
 50 mm x 50 mm (2" x 2") flashing is an example of a way to break the contiguity between the back cavity and the under-roof air space. There are other possible methods. Please refer to the responsible authorities.

a) With eaves

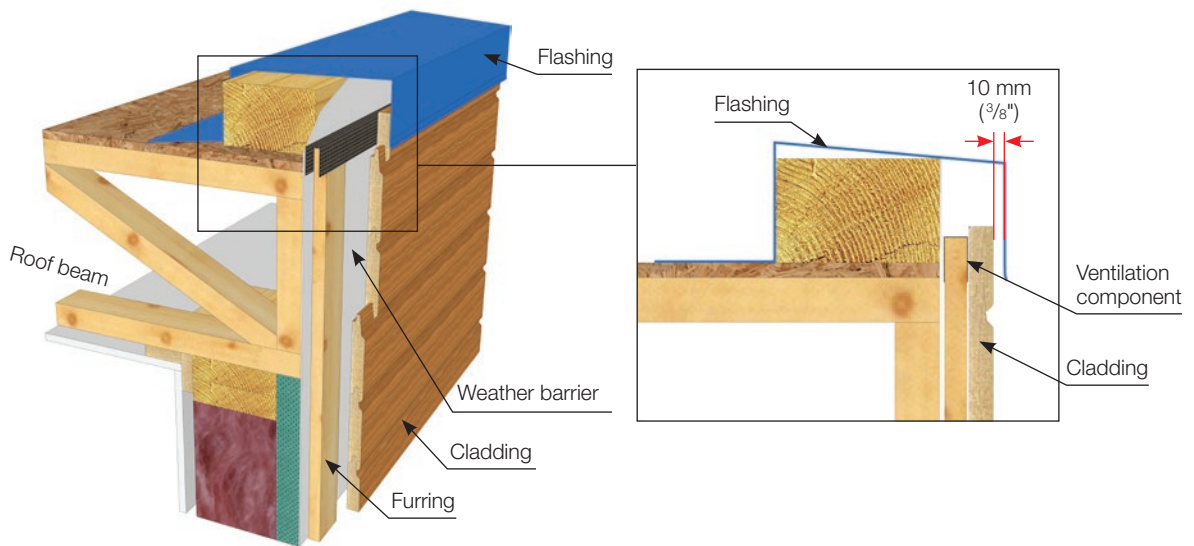

b) Without eaves

FIGURE 14 • Opening at top of walls with and without eaves

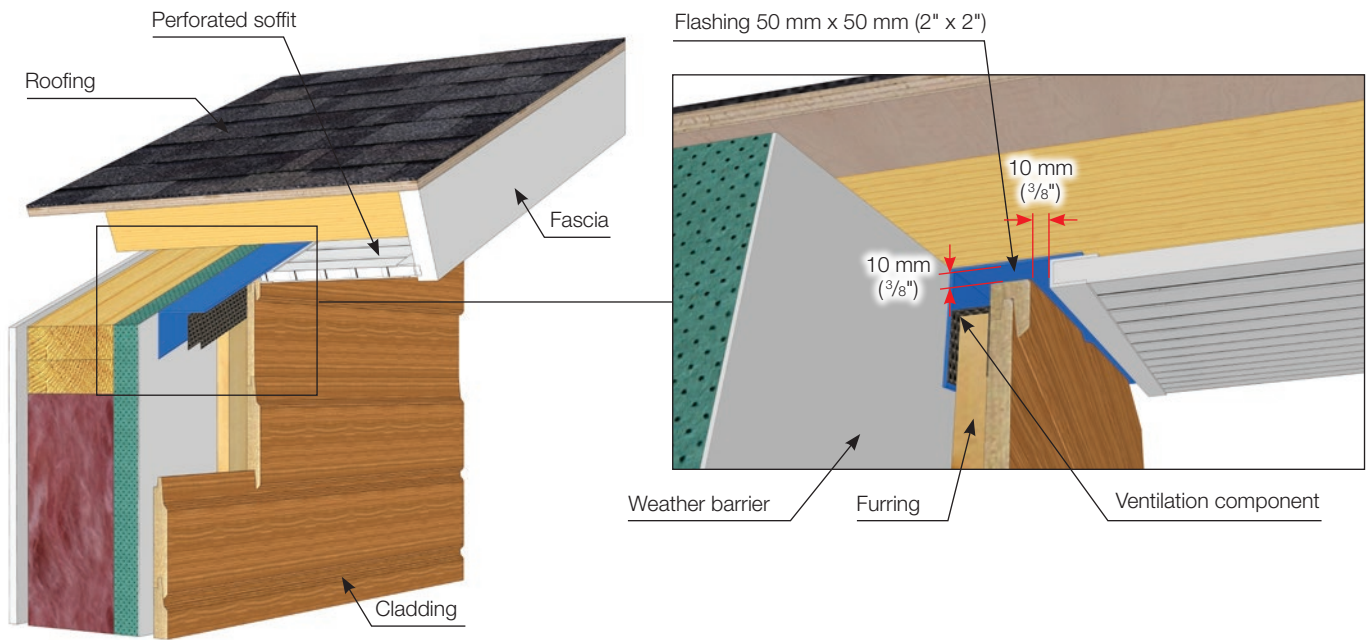

a) For horizontal cladding

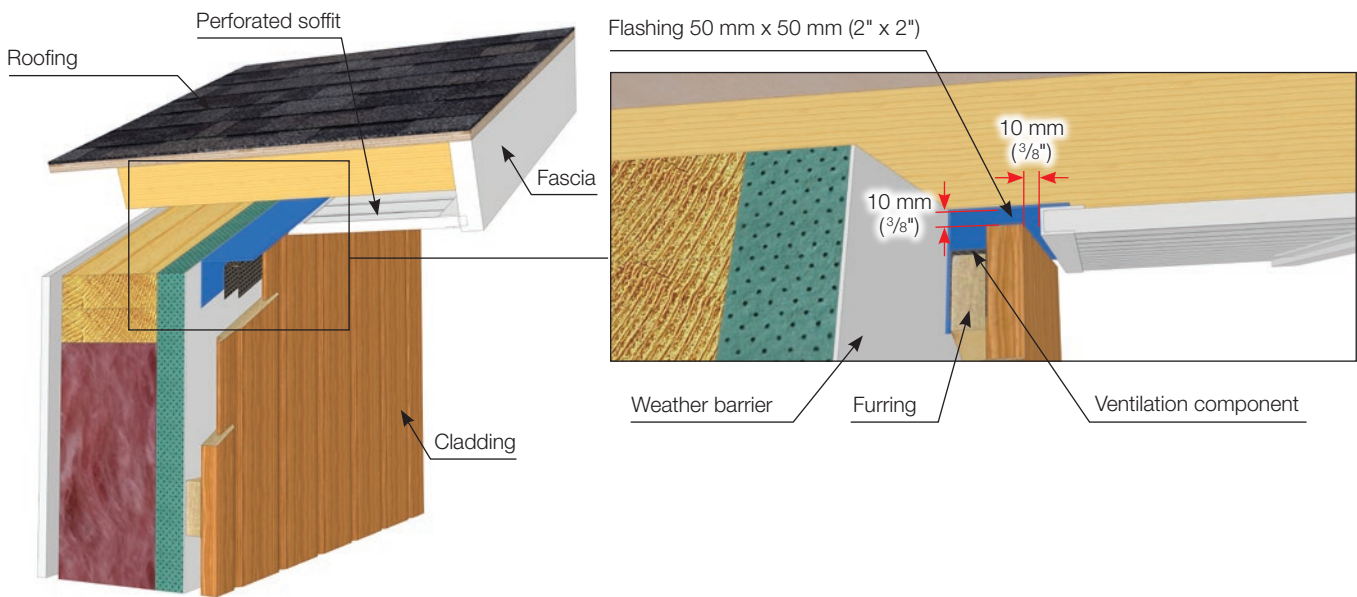

b) For vertical cladding

FIGURE 15 • Opening at top of a gable

On the other hand, remember that for walls with a flat surface greater than 6 metres tall, it is required to break up the air space with free openings of 10 mm (3/8 in), as illustrated in **Figure 16**. Otherwise, the

thickness of the drainage and ventilation cavity must be increased to compensate for a greater amount of air to ventilate. It is suggested that you place this break at the floor edges.

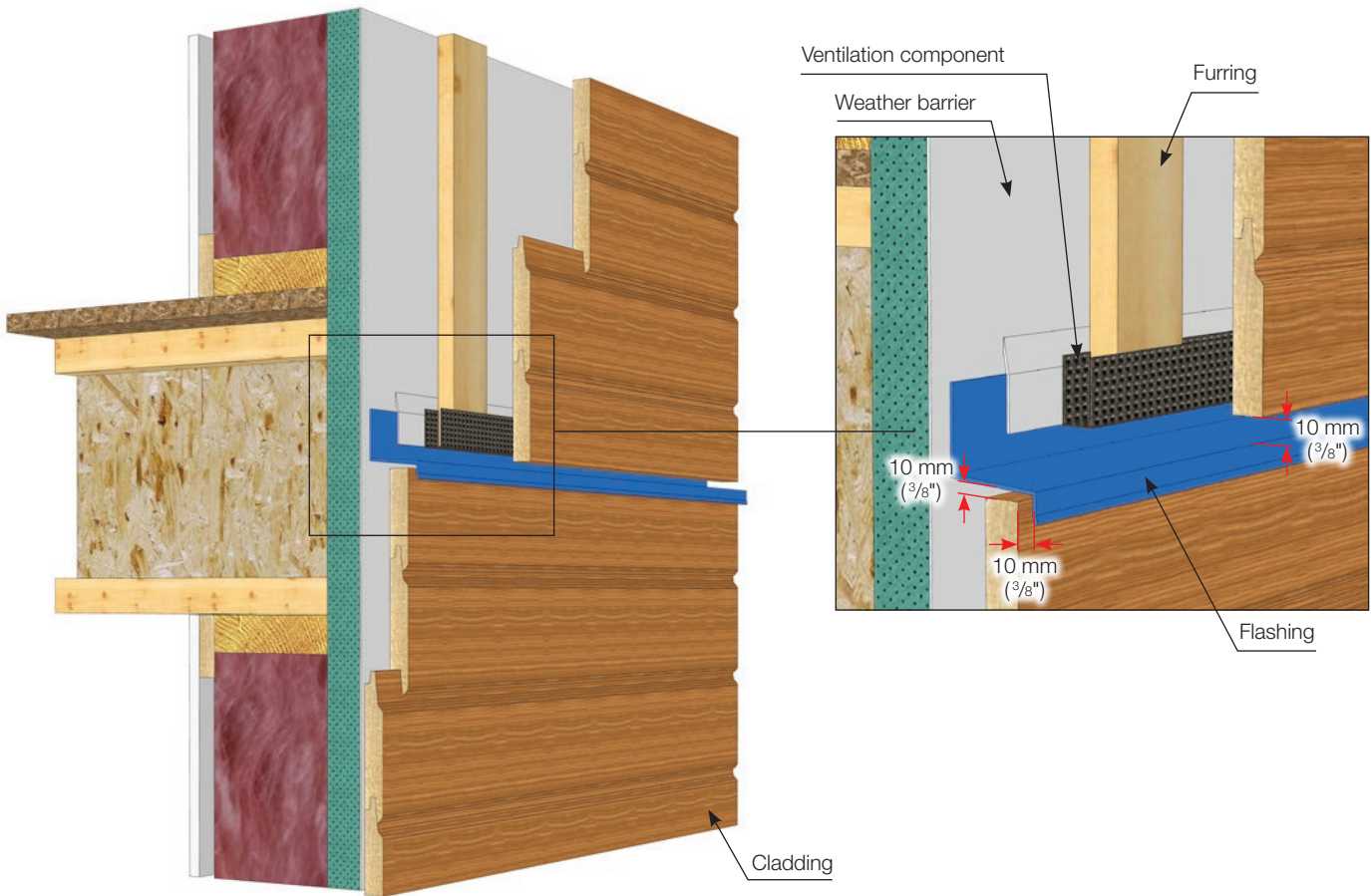

FIGURE 16 • Interruption of air space for cladding surfaces taller than 6 m

2.2.2 Open space of cladding back cavity

The open area of the back cavity depends on furring thickness, furring spacing and the airflow of the ventilation component (moulding, screen, etc.). Ventilation components with perforations (quantity and dimensions) allowing for the free flow of air and providing an open free space of at least 10 continuous mm (3/8 in), at the base and top of the walls, will provide the minimum open air space necessary for most wall lathing. These openings must not be obstructed by sealant or any other material that could hinder airflow.

2.3 Organization of lengths and butt joints

For a natural effect and to distribute the effects of potential longitudinal shrinkage or swelling, it is best to vary board lengths and spread out the butt joints on the wall to avoid having them in alignment. The distribution of lengths on the wall should be planned as follows:

- Distribute the boards in a way that limits the number of joints on the wall
- Position the lengths according to the length of spaces to cover to minimize the number of breaks
- As much as possible, avoid joints above openings to limit potential points of water ingress

- Avoid placing two boards that are 3.6 m (12 ft) to 4.8 m (16 ft) long end to end
- It is recommended to insert shorter lengths between long boards
- A wood or metal vertical transition moulding is necessary when making fixed-length wall sections

Positioning of non-tongue and groove cladding

For non-tongue and groove cladding, joints must be aligned with furring to solidly attach the ends of cladding boards to each other.

Positioning of tongue and groove cladding (irregular installation)

Several manufacturers now offer cladding boards with edges containing tongues and grooves. This maximizes wood use and lengths in a “random” installation, distributing the butt joints at different lengths along the wall.

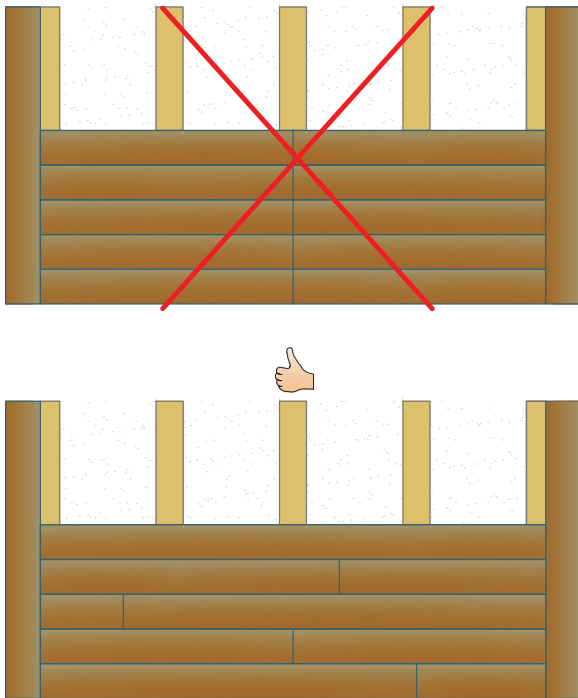

FIGURE 17 • Positioning of lengths and joints

2.4 Cutting

2.4.1 Cutting methods

For a high-quality cut, use a finish blade. Regular cutting blades tend to make coarse cuts that are not smooth.

End cut

End cuts at a 22.5° angle are recommended, rather than a 90° angle, for higher quality and to prevent being able to see through the joint in case of wood shrinkage. A 22.5° angle is suggested to prevent splintering or breaking at the end of the cut, compared to a 45° cut. It is not necessary to leave spacing, because the ends must be supported on top of the other.

When pieces are installed vertically—mouldings, cladding, etc.—it is essential to cut at an angle that allows water to run off towards the exterior.

When pieces are installed horizontally, it is best to cut so that the angle will face the least visible side of the building.

As specified in section 2.5, it is important to apply a finish product to the ends of the pieces prior to installation.

Junction cut

For cuts to delineate a corner or an opening, 90° angle cuts are recommended, while planning for a clearance of about 3 mm (1/8 in) maximum to allow for wood movement. This spacing will be covered in sealant (section 2.8).

For outer wall corners, do not use a 45° angle cut because wood movement over time will create openings that allow water ingress. Exterior corner mouldings are recommended instead.

When using metal corner moulding, the same spacing and weather stripping precautions apply.

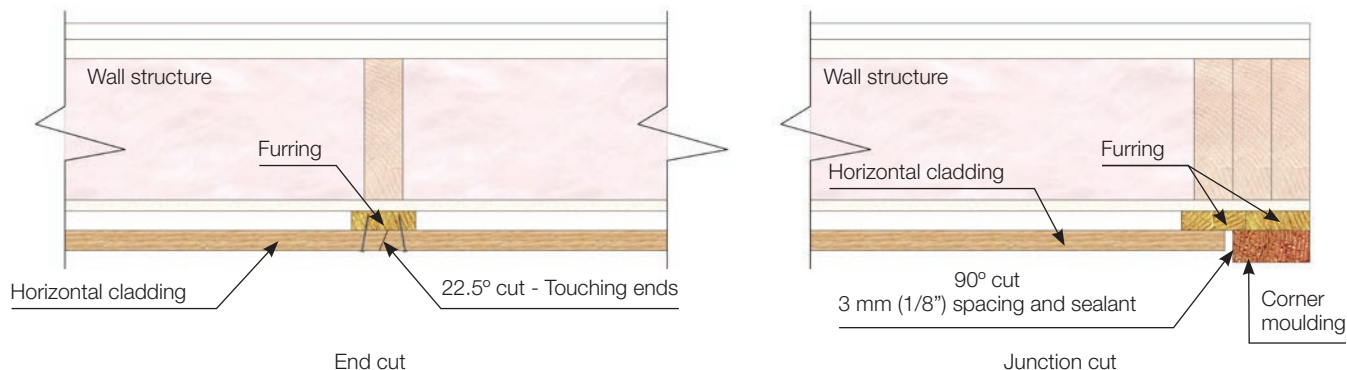

FIGURE 18 • Cut to make at end and junction joints

2.4.2 Removing flaws prior to installation

Wood contains distinctive marks that increase its visual value. Taking these characteristics into account, factory work is done following strict and highly detailed quality criteria to remove abnormalities that could allow water to enter through the cladding. In spite of this, the final product may still contain some irregularities. In addition, transportation and storage may cause breaking. As such, it is up to the client or installer to plan for a percentage of lost for any material that will be cut, and to perform a final inspection of the boards before installation. On the other hand, a client or installer may want to remove some or all distinctive marks for a more uniform and pared-down appearance. Remember that this operation will increase material loss and is not necessary from a product performance perspective.

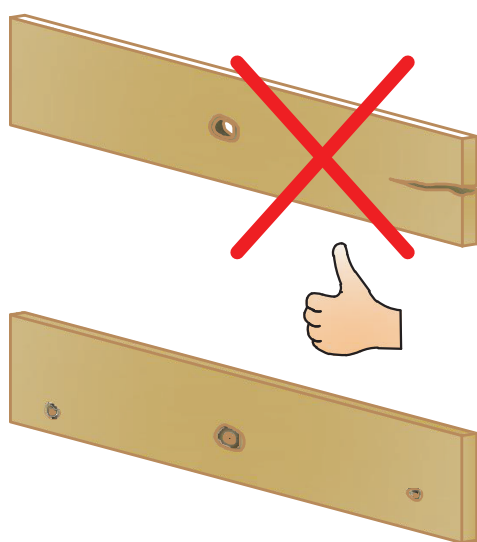

FIGURE 19 • Final inspection by installer

2.5 Touch-ups

2.5.1 How and why to touch up

During installation, any alterations to the surface finish, such as cuts or fasteners, can allow water ingress and product damage. Everywhere the wood is stripped down, it must be protected from potential damage by reapplying sufficient finish product. The objective of modifications is to seal the stripped parts using the finish product provided or recommended by the manufacturer.

Apply a layer of finish product to saturate the pores. A second layer may be advisable in some cases. Touch-ups must be done using a brush or applicator sized appropriately for the necessary touch-ups. It is important not to reapply the touch-up product on top of the finish already in place to avoid changing its appearance. For example, when installing with visible nails, the unfinished nail heads should be touched up with the brush point without going over the edges to the wood around it.

2.5.2 Application conditions

Since the objective behind touch-ups is to seal the stripped areas of wood, it is essential that the conditions allow the product to penetrate the wood.

For this to happen, the wood and finish product must be at an adequate temperature, in particular to ensure optimal product viscosity. Cladding producers refer to their finish product manufacturers, and generally the application temperatures must be higher than 10° C.

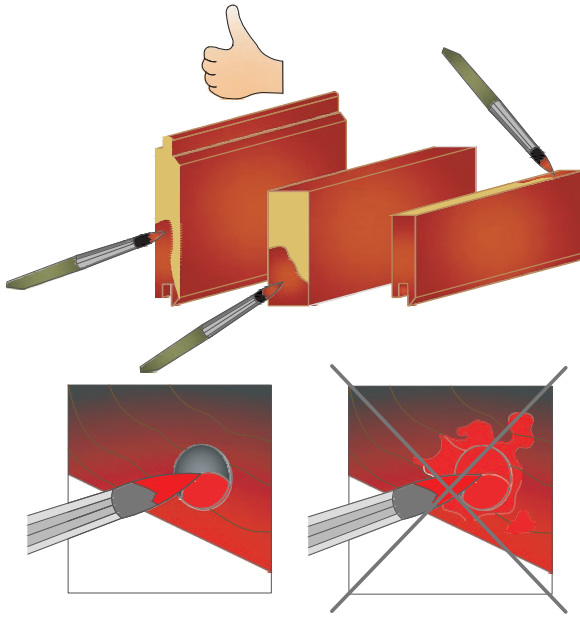

FIGURE 20 • Applying touch-ups

When two coats are necessary, the first coat must be dry before the second is applied, unless otherwise indicated by the finish product manufacturer. All 6 faces/edges of the siding should be covered by a finish product and no surface should be left exposed to the elements.

It is important to protect the touch-up product from freezing before and during its use to avoid altering its properties.

2.6 Cladding fasteners

2.6.1 Types of fasteners



Nails

Nails are the recommended type of fastener for installing cladding with visible attachments and mouldings. The specifications are as follows:

- For cedar cladding: 304 stainless steel nails (or 316 for coastal regions) only
- For other types of wood: nails made of 304 stainless steel (or 316 for coastal regions) or hot-dip galvanized steel nails

- Ringed body
- Flat textured head with 1/4 in diameter
- Minimum length:
 - 50 mm (2 in) minimum for cladding and moulding that has a thickness of 19 mm (3/4 in) or less.
 - 64 mm (2 1/2 in) minimum for cladding and moulding that has a thickness of 32 mm (1 1/4 in) or less.
 - For thicker moulding and cladding, see manufacturer recommendations.

Never use mild steel fasteners that are not corrosion resistant, because rust stains the cladding surface finish and compromises the fastener's integrity.



Staples

For concealed-fastener cladding (interlocking tongue-and-groove system), staples are recommended for all hidden fasteners. The specifications are as follows:

- For cedar cladding: 304 stainless steel staples (or 316 for coastal regions) only
- For other types of wood: staples made of 304 stainless steel (or 316 for coastal regions) or galvanized steel staples
- Calibre: 16
- Minimum width: 11 mm crown (7/16 in)
- Minimum length: 50 mm (2 in)
- Coated in resin

However, some attachments cannot be hidden in concealed-fastener cladding installations, and visible fasteners are needed: cladding boards whose interlocking systems were cut or places where the stapler can't reach. The manufacturer-provided nails described above can be used particularly in the following situations:

- First row at base of wall
- Cladding board above an opening (window or door)
- Cladding board under a window
- Final cladding board at top of wall

2.6.2 Anchorage depth

Article 9.27.5.7.2 of the National Building Code (NRC, 2015) stipulates that, for optimal cladding performance, fasteners must cross the furring strips or penetrate at least 25 mm (1 in) into a solid nail-holding base. This nail-holding base may be made up of furring strips and solid wood (panel of OSB, plywood, CLT). Calculating the depth of penetration in the nail-holding base takes into account the thickness of the cladding and incident angle.

For most cladding 19 mm (3/4 in) thick or less, a 51 mm (2 in) long staple, placed at an incident angle between 20 and 30 degrees, will penetrate the furring as specified in the National Building Code (NRC, 2015). In addition, attaching a 50 mm (2 in) long nail, at a right angle (90 degrees), on cladding from 19 to 25 mm (3/4 to 1 in) thick, will fully penetrate the furring.

Corner and framing moulding with a thickness of 32 mm (1 1/4 in) and battens require the use of a nail at least 64 mm (2 1/2 in) long, which will penetrate through the furring.

2.6.3 Fastener positioning

Concealed-fastener cladding

For concealed-fastener cladding, the base of each board is held by interlocking with the board below. However, the upper side of the board must be attached with two fasteners per furring strip. For this, many manufacturers place a staple line on their channels. If this line is not present, the staple must be positioned so that it will be covered by the board above and inserted at the incident angle required to penetrate through the whole width of the board, and not just the upper tongue. Use two staples per furring strip with a recommended spacing of 19 mm (3/4 in) between the staples (**Figure 21a**). Some manufacturers also provide a guide that can be used with certain commercial staplers to ensure proper fastener location and angle.

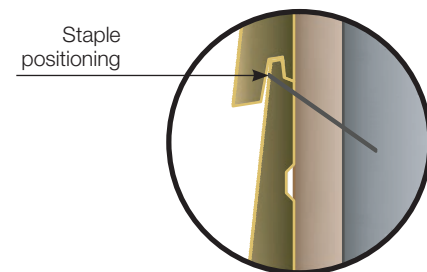
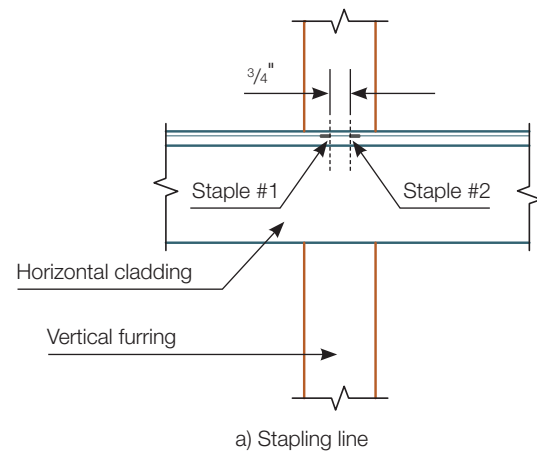

b) Concealed by the board above

FIGURE 21 • Fastener location for staples on cladding

Cladding with visible fasteners (nails with heads)

Cladding with visible fasteners with length varying between 100 and 150 mm (4 and 6 in) must be nailed around 25 mm (1 in) from the base of the cladding boards with one fastener (1 nail) per furring strip. The nail must penetrate through the full cladding thickness and be far enough from the lower lip to prevent splitting.

When the cladding has a width of 200 mm (8 in) or more, at least one more fastener is required. There are therefore at least two nails per board on each furring.

Refer to the manufacturer's installation guide for more details regarding the number and location of fasteners depending on the different shapes.

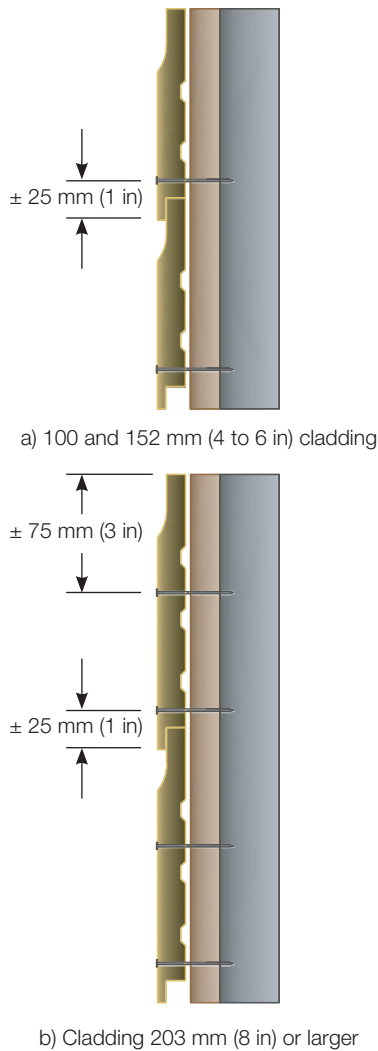

FIGURE 22 • Fastener location for nails on cladding

For moulding, one single fastener point is recommended when the width is under 50 mm (2 in), and two fastener points are necessary for widths greater than 50 mm (2 in), with each point located about 19 mm (3/4 in) from the edge. For all widths, fastener points should ideally be spaced 400 mm (16 in) apart or less.

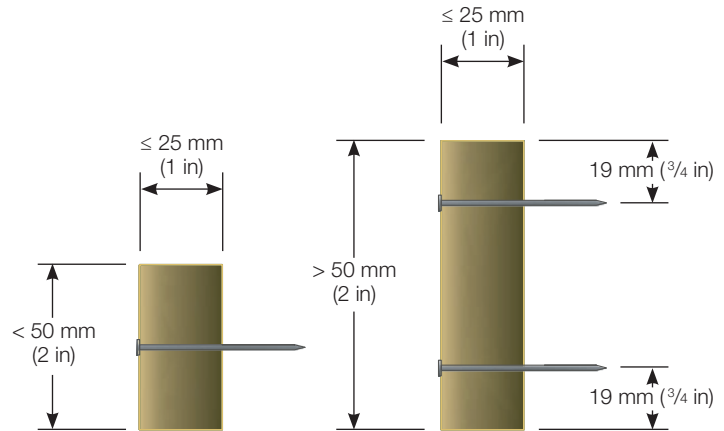

FIGURE 23 • Fastener location for nails on moulding

2.6.4 Proper installation of fastener

For optimal cladding performance, it is important to follow these instructions:

- Head (or crown) penetration

The nail heads or staple bases must rest on the wood and must not penetrate the surface, because then the perforation becomes a leakage point and weakens the board attachment.

- Press the cladding board in well before fastening it.
- Avoid stapling or nailing too close to the edges to prevent wood splitting.
- It is sometimes ideal to pre-drill cladding to attach boards when the fastener is too close to the edge or one end.

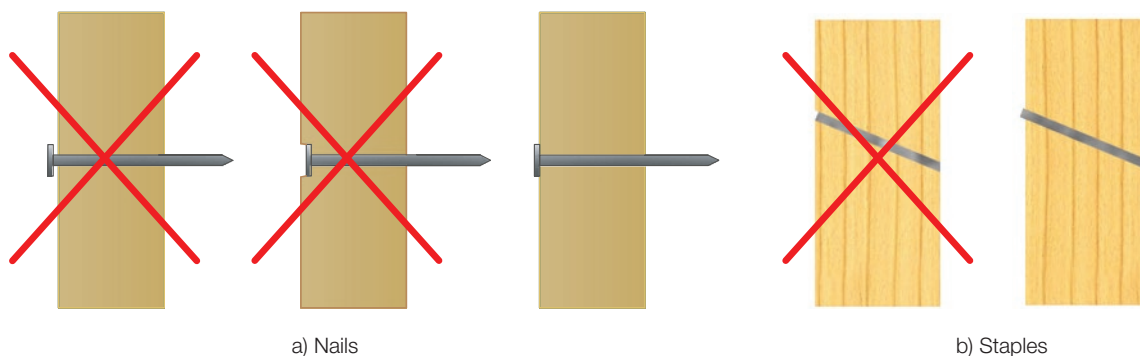

FIGURE 24 • Fastener penetration

2.7 Installing cladding



2.7.1 Installing horizontal cladding

- 1- With a laser level, locate the reference line to cover the lowest point on the walls to be covered.
- 2- Mark this reference line on the full perimeter of the building and copy it higher on the wall as a reference for installing cladding boards. If the building has more than one floor, transfer the reference line throughout the installation.

- 3- Install inside and outside corner mouldings by aligning their base on the reference line.

Note: some installers will prefer to use temporary pieces instead of permanent mouldings, which are installed at the end.

- 4- Install framing mouldings (doors, windows, other).
- 5- Install all required flashing (section 1.4).
- 6- For every section of the wall that needs cladding, spread out boards based on the board lengths available. This will help you minimize waste and produce a better appearance (section 2.3).

Base of wall and first row

7a - With ventilated metal starting grille:

- Install the metal grille on all walls to be covered in cladding following the reference line, making sure that it overlaps the concrete foundation by 25 mm (1 in) (**Figure 13**).
- Install the first row of cladding by pressing it into the metal moulding with the tongue side facing up.

7b - Without ventilated metal starting grille:

- Using a stapler, install the screen by inserting it under the furring strips and folding it over.
- Install the first cladding board following the reference line.
- The cladding board must overlap the concrete foundation by 25 mm (1 in).

7c - With horizontal wood finish moulding:

- Install the screen or metal grille as described above by inserting it under the furring strips and folding it over.
- Install the horizontal wood finish moulding following the reference line. The moulding must overlap the concrete foundation by 1 in (25 mm).
- Install flashing to protect the flat surface of the horizontal wood finish moulding. Make sure to leave a clearance of 10 mm (3/8 in) between the horizontal surface of the flashing and the ends of the vertical boards. This clearance space must be free of sealant or any other obstruction. Refer to finish mouldings at the top of openings (**Figure 9**).

- 8- Mark the corners of the adjacent walls every 4 rows, all the way up to the top of the wall. These markings will ensure that the rows will align from one wall to the next.

Once the starting grille and first row have been installed levelly on all of the walls, proceed wall by wall:

- 9- Install the next 3 rows.
- 10- Check the level compared to the reference line and adjust as needed.
Note: If an adjustment is necessary, spread out the correction over the next 4 rows. Never make a correction over a single row.
- 11- Repeat the above by group of 4 rows, checking the level with each group

Top of wall

- 12- Install a device to break up the contiguity between the air space and the under-roof air space. See section 2.2, **Figure 14** as well as the manufacturer installation guides for more details.
- 13- Install the ventilated metal grille or screen.
- 14- Cut the final cladding board width-wise to maintain an opening of 10 mm at the top of the wall. Use nails to fasten the top of the strip of cladding.
Note: it is possible to add a finish metal or wood moulding (grille) to hide this opening if desired.
- 15- Install a finish drip (flashing) to stop rainwater ingress if the eaves are shorter than four times the space of the opening (**Figure 14**).
Note: since the recommended opening is 10 mm (3/8 in), a finish drop is necessary if the eaves are shorter than 40 mm (1 1/2 in).
- 16- Complete the other walls.
- 17- Touch up and apply sealant to appropriate locations (sections 2.5 and 2.8).

2.7.2 Installing vertical cladding (tongue and groove or lap)

- 1- With a laser level, locate the reference line to cover the lowest point on the walls to be covered.
- 2- Mark this reference line along the full building perimeter.
- 3- Install interior corner mouldings by aligning their base with the reference line.
- 4- Install framing mouldings (doors, windows, other).

- 5- Install all required flashing (Section 1.4).
- 6- For every section of the wall that needs cladding, spread out boards based on the board lengths available. This will help you minimize waste and produce a better appearance (Section 2.3).
- 7- On the lowest horizontal furring strip and on a furring strip at 2/3 of the height for the section requiring cladding, make a mark to check the alignment every four rows.

Wall base

- 8a- With ventilated metal starting grille:
 - Install the starting metal grille on all walls to be covered in cladding following the reference line, making sure that it overlaps the concrete foundation by 25 mm (1 in) (**Figure 13**).
- 8b- Without ventilated metal starting grille:
 - Using a stapler, install the screen by inserting it under the furring strips and folding it over.
- 8c- With horizontal wood finish moulding:
 - Install the screen or metal grille as described above by inserting it under the furring strips and folding it over.
 - Install the horizontal wood finish moulding following the reference line. The moulding must overlap the concrete foundation by 1 in (25 mm).
 - Install flashing to protect the flat surface of the horizontal wood finish moulding. Make sure to leave a clearance of 10 mm (3/8 in) between the horizontal surface of the flashing and the ends of the vertical boards. This clearance space must be free of sealant or any other obstruction. Refer to finish mouldings at the top of openings (**Figure 9**).

Top of wall

- 9- Install a device to break up the contiguity between the air space and the under-roof air space. See section 2.2, **Figure 14** as well as the manufacturer installation guides for more details.
- 10- Install the anti-rodent metal grille or screen.
- 11- Cut the ends of the vertical cladding boards to maintain an opening of 10 mm at the top of the wall.

- 12- Install a finish drip (flashing) to stop rainwater ingress if the eaves are shorter than four times the space of the opening (**Figure 14**).

Note: since the recommended opening is 10 mm (3/8 in), a finish drip is necessary if the eaves are shorter than 40 mm (1 1/2 in).

First row

- 13- Ideally, determine the direction of dominant winds and direct each board so that the tongues face the wind to minimize the risk of rainwater entering the grooves.
- 14- Cut the cladding boards to maintain an opening of 10 mm at the top of the wall.
- 15- Cut the bottom of the boards at a maximum angle of about 15 degrees to allow for water to run off towards the exterior.
- 16- Install the first board, making sure it is plumb and fastening it with visible nails.
- 17- If edges need to be trimmed, make sure to touch up the stripped wood with the recommended finish product.
- 18- Install the next three rows.
- 19- Verify that they are plumb.
Note: If an adjustment is necessary, spread out the correction over the next 4 rows.
- 20- Repeat the above by group of four rows, checking the level with each group.

Final row

- 21- Cut the edges of the boards that will be on the corner. Cut them on the tongue side, making sure to protect the stripped edges with two coats of the recommended finish.
- 22- Install the corner board or boards making sure they are plumb.
- 23- Complete the other walls.
- 24- Touch up and apply sealant to appropriate locations (sections 2.5 and 2.8).

2.8 Sealant



2.8.1 Sealant's role

To limit the risk of leaks, a sealant must be used. The sealant acts as the first protection in the rainscreen, in combination with the cladding itself, to block all potential water entry.

2.8.2 Sealant location

The sealant must be applied with precaution everywhere that water may enter. This is the case along a vertical joint, where the cladding meets the moulding (sides of doors, sides of windows, corners).

Remember that proper installation of flashing above openings does not require sealant. Properly installed flashing blocks potential leaks. However, leave a 10 mm (3/8 in) space between the cladding and the base of the flashing for good ventilation. If the horizontal covering of the flashing does not hang over the underlying element, you must apply a sealant joint to prevent water ingress under the flashing. (See masonry sleeper wall example in section 1.6.)

2.8.3 Choosing a sealant

There are many sealant products on the market. This guide refers to section 9.27.4.2 of the NBC for sealant specifications (NRC, 2015). Generally speaking, sealants should be:

- A non-hardening type (flexible) for exterior use
- Selected for their ability to resist the effects of weathering
- Compatible with and adhere to the substrate to which they are applied
- Free of or have very low levels of volatile organic compounds (VOCs)

2.8.4 Sealant application

When applying sealant, always follow the sealant manufacturer's recommendations.

The sealant bead must adhere correctly to the two surfaces creating the opening. For openings greater than 6 mm (1/4 in), it is recommended that you first install a filler product in the opening and then cover it with sealant. In addition, the sealant must always be placed between two parallel, non-perpendicular surfaces.

Sealant is not a permanent solution, and requires regular maintenance. If the sealant joints are not inspected and maintained regularly, they may fail, trap water and alter the cladding, or even cause more serious mold and rot issues inside the wall structure.

3 Maintenance

Regular, preventative maintenance is recommended for cladding in order to preserve its original appearance, prevent deterioration and ensure wood longevity. An annual inspection can serve to check the state of the cladding and the sealant joints.

3.1 Cleaning



Annual washing is recommended in order to remove any grime (mold, dirt, spiderwebs, etc.).

The cladding can be cleaned simply using a water hose with low pressure and a soft brush, like one used to wash a car body. A mild cleanser may be added, without bleach, ammonia or abrasive elements. As necessary, cleaners can be tested on a small surface to make sure they do not damage the cladding. After washing, it is best to rinse gently with a low-pressure water hose.

NOTE: Never use a pressure washer.

Some types of wood may let off sap when the cladding is exposed to hot summer temperatures. To remove the sap, brush it when dry with a simple, dry non-metal brush. The white powder produced by brushing can be rinsed with water using a low-pressure hose. This cleaning method can be repeated as needed if additional sap comes out of the wood after several seasons have gone by. This operation may require minor paint touch-up.

3.2 Minor maintenance

Immediately after installing the cladding and then annually, it is strongly recommended that you visually examine surfaces in order to fix areas affected by scratching or splitting following an impact. On any surface with bare wood, apply the finish product provided by the manufacturer, taking care to limit its application to the bare area to avoid changing the colour of the rest of the cladding. A cotton swab or a thin paintbrush can be used for fine application. The touch-up product must be applied following the manufacturer's specified conditions (e.g. exterior temperature during application, drying time before second coat, etc.).

Minor maintenance will be necessary as the seasons go by after any scratching or impacts for various reasons (bicycle propped up on the siding, stone kicked up by snow blower, etc.). A visual examination is the best way to make required fixes, following the recommendations above for touch-ups. However, remember that the colour of the cladding may fade over time.

If a sealant joint needs a correction, it must be removed cleanly without damaging the surface finish. In this case, the stripped sections need to be touched up before reapplying a bead of sealant.

9 References

Association des professionnels de la construction et de l'habitation du Québec (APCHQ). 2017.

– Collection of specifications: <https://www.apchq.com/documentation/technique/fiches-technique>

– Check point collection: <https://www.apchq.com/documentation/technique/fiches-de-point-de-contrôle>

National Research Council Canada (NRC). 2012. Supplement to the NBC 2010. Intent Statements.

Published by the Canadian Commission on Building and Fire Codes.

National Research Council Canada

National Research Council Canada (NRC). 2015. The National Building Code 2010 (NBC). Published by the

Canadian Commission on Building and Fire Codes (CCBFC). <http://www.nrc-cnrc.gc.ca/fra/publications/>

[centre_codes/2015_code_national_batiment.html](http://www.nrc-cnrc.gc.ca/fra/publications/centre_codes/2015_code_national_batiment.html)

cecobois & Wood *WORKS!* thanks its sponsors



Dépôt légal Bibliothèque nationale du Québec
Dépôt légal Bibliothèque nationale du Canada

April 2020

cecobois

Centre d'expertise
sur la construction
commerciale en bois

www.cecobois.com